

RoHS

THIS IS A RoHS COMPLIANT COMPONENT/PRODUCT.

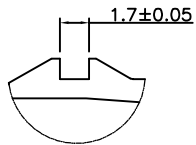

DETAIL "A"
SCALE 2:1

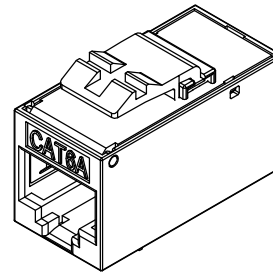
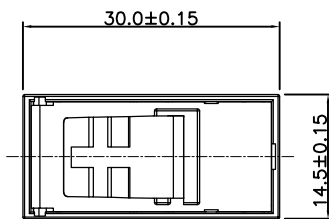

NOTES:

ELECTRICAL:

1. VOLTAGE RATING: 125 VAC RMS.
2. CURRENT RATING: 1.5 AMP.
3. CONTACT RESISTANCE: 20 MILLIOHMS MAX.
4. INSULATION RESISTANCE: 1000 MEGOHMS MIN @ 500 VDC.
5. DIELECTRIC STRENGTH: 750 VAC RMS 60Hz,1MIN.

ENVIRONMENTAL:

1. STORAGE: -40°C TO +85°C.
2. OPERATION: -40°C TO +85°C.

MECHANICAL:

1. HOUSING MATERIAL: ZINC
2. INSERT MATERIAL: PLASTIC UL94V-0
3. PCB MATERIAL: FR-4
4. CONTACT MATERIAL: PHOSPHOR BRONZE
5. PART NUMBER: N4465-006-0X

- 01: W/6A LOGO PC WHITE
- 02: W/6A LOGO PC BK
- △ 03: W/6A LOGO PC WHITE (pcb update)
- △ 04: W/6A LOGO PC BK (pcb update)
- △ 05: W/6 LOGO PC WHITE
- △ 06: W/6 LOGO PC BK

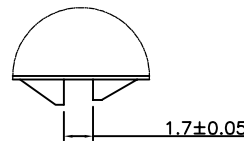
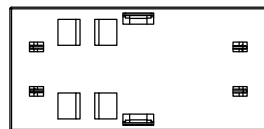
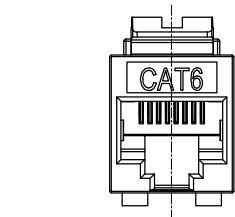
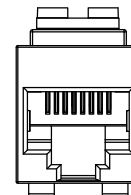
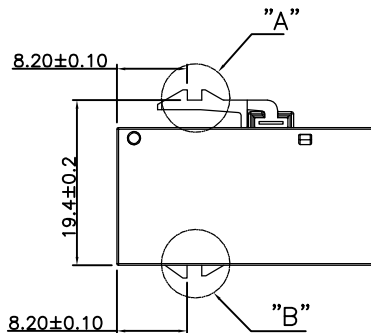
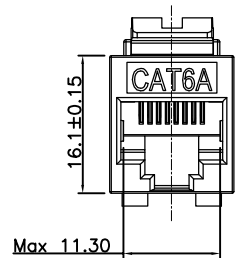

DETAIL "B"
SCALE 2:1

△ X3		ADD NEW P/N	LONNY	090622'	
△ X1		ADD NEW P/N	LONNY	082522'	
△ X0	0069000	NEW DESIGN	HENRY	041620'	
MARK	ECN-NO.	REVISION RECORD	DRAWN	DATE	
 Contact Technology Co., Ltd.		UNLESS OTHERWISE SPECIFIED TOLERANCE	SCALE	CHECKED	
		Dimension Range	Tolerance	1:1	
		X.X	±0.20	UNIT	APPROVED
		X.XX	±0.15	mm	
X.XXX	±0.10	SIZE	A3		
ANGLE	±5°				
Material/Plated/Notes		NAME			
SEE NOTE		DIE CASTING COUPLER KEYSTONE FTP JACK			
Tooling No.		PART NO.	SEE NOTE	REV.	
		DOC. NO.	NN446A006	C	