

RoHS

THIS IS A RoHS
COMPLIANT
COMPONENT/
PRODUCT.

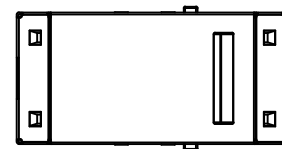
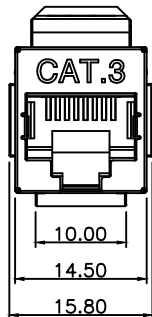
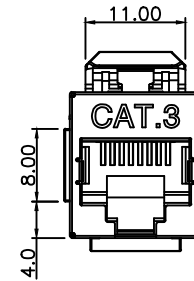
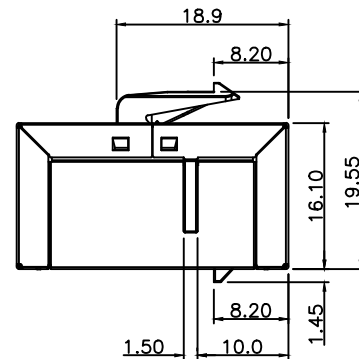
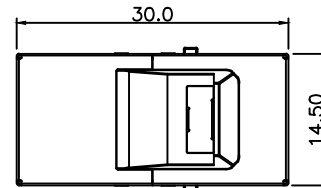
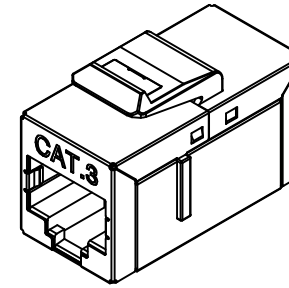

NOTES:

ELECTRICAL:

1. VOLTAGE RATING: 125 VAC RMS.
2. CURRENT RATING: 1.5 AMP.
3. CONTACT RESISTANCE: 100 MILLIOHMS MAX.
4. INSULATION RESISTANCE: 1000 MEGOHMS MIN @ 500 VDC.
5. DIELECTRIC STRENGTH: 750 VAC RMS 60Hz,1MIN.

ENVIRONMENTAL:

1. STORAGE: -40°C TO +85°C.
2. OPERATION: -40°C TO +85°C.

MECHANICAL:

- 1.HOUSING MATERIAL:PLASTIC UL94V-0
- 2.INSERT MATERIAL:PLASTIC UL94V-0
- 3.PCB MATERIAL:FR-4
- 4.SHIELD MATERIAL:SUS-301 0.20mm

PART NUMBER: N446X-028-0X

- 1-3u" 2-6u" 01: C3 WHITE
- 3-15u" 4-30u" 02: C3 BK
- 5-50u"

ΔX0	000000	NEW DESIGN	Patrick	092222'	
MARK	ECN-NO.	REVISION RECORD	DRAWN	DATE	
 Contact Technology Co., Ltd. Material/Plated/Notes SEE NOTE		UNLESS OTHERWISE SPECIFIED TOLERANCE	SCALE	CHECKED	
		Dimension Range	Tolerance	1:1	APPROVED
		X.X	±0.20	UNIT	SHEET 1/1
		X.XX	±0.15	mm	
X.XXX	±0.10	SIZE			
NAME		ANGLE	±5°		
PART NO.		CAT.3 FTP COUPLER W/ LATCH			
TOOLING NO.		REV. 0			
DOC. NO.		NN446A028			