

RoHS

THIS IS A RoHS COMPLIANT COMPONENT/PRODUCT.

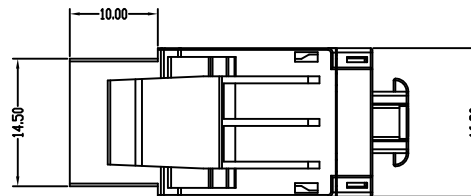
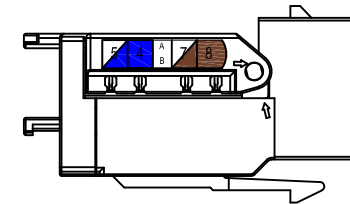
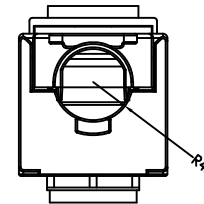
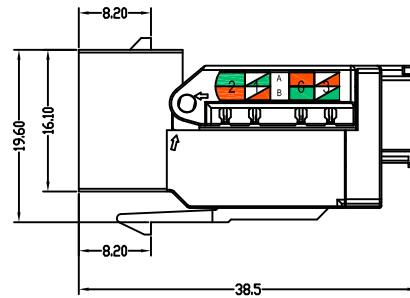
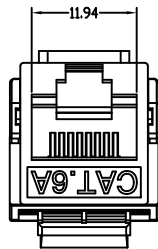
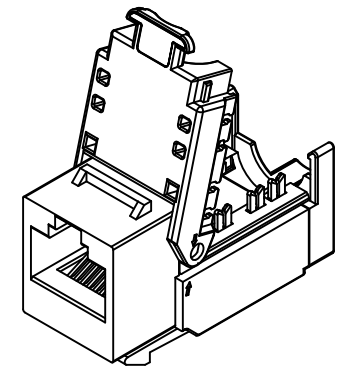
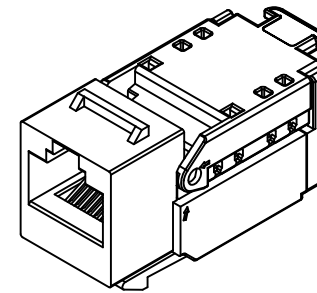
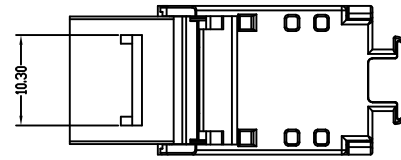

NOTES:

ELECTRICAL:

- 1. VOLTAGE RATING : 125 VAC
- 2. CURRENT RATING : 1.5 AMP.
- 3. CONTACT RESISTANCE : 20 MILLIOHMS MAX.
- 4. INSULATION RESISTANCE : 1000 MEGOHMS MIN. @ 500 VDC.
- 5. DIELECTRIC STRENGTH : 750 VAC 60Hz, 1 MIN.

MECHANICAL:

- 1. HOUSING MATERIAL : PC UL94V-0
- 2. INSERT MATERIAL : PC UL94V-0
- 3. COVER MATERIAL : PC UL94V-0
- 4. FCC COVER MATERIAL : PC UL94V-0
- 5. PCB MATERIAL : FR-4 THICKNESS 1.2 mm
- 6. CONTACT MATERIAL : PHOSPHOR BRONZE STAMP PIN t=0.3 mm  
Gold plating over 30-80 micro-inch Nickel plated
- 7. IDC CONTACT MATERIAL : PHOSPHOR BRONZE t=0.50 mm WITH NICKEL PLATING
- 8. WIRE : #23~26 AWG

ENVIRONMENTAL:

- 1. STORAGE : -40°C TO +85°C.
- 2. OPERATION : -40°C TO +85°C.

CONFORMING TO TIA/EIA 568B  
MATES WITH MODULAR PLUG CONFORMING TO TIA-1096-A.

PART NUMBER: N445X-172-0X

1-3u' 2-6u' 3-15u' 1-WHITE  
4-30u' 5-50u'

△	0000000	NEW DESIGN	LONNY	061623'
MARK	ECN-NO.	REVISION RECORD	DRAWN	DATE
 Contact Technology Co., Ltd.	UNLESS OTHERWISE SPECIFIED TOLERANCE		SCALE	CHECKED
	Dimension Range	Tolerance	1/1	APPROVED
	X.X	±0.20	UNIT	
	X.XX	±0.15	mm	
X.XXX	±0.10	SIZE	A3	
ANGLE	±5°			
Material/Plated/Notes	NAME			
SEE NOTE	90° CAT6A TOOLLESS KEYSTONE			
Tooling No.	PART NO. N445X-172-01		REV. A	
	DOC. NO. NN445A172			

Design drawing