

RoHS

THIS IS A RoHS COMPLIANT COMPONENT/PRODUCT.

"T" LOGO OPTION

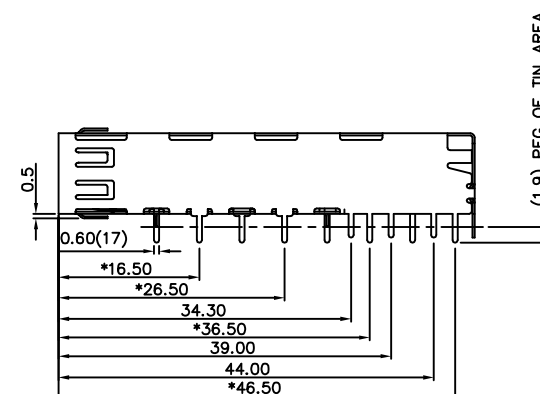
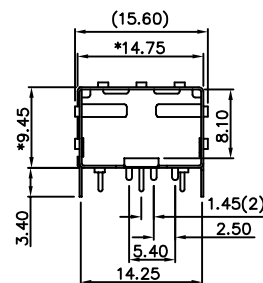
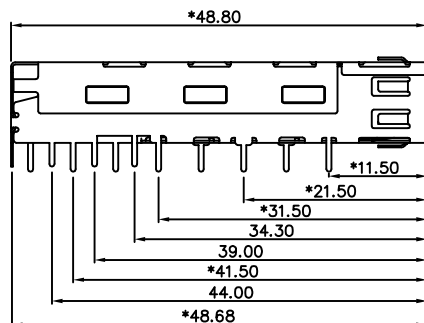
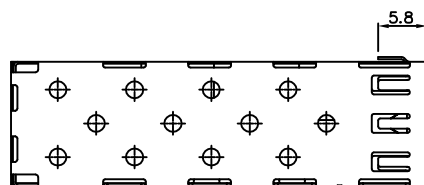
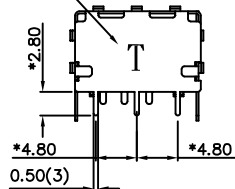

CROSS-HATCHED AREA DENOTES COMPONENT AND TRACE KEEP-OUT (EXCEPT CHASSIS GROUND)

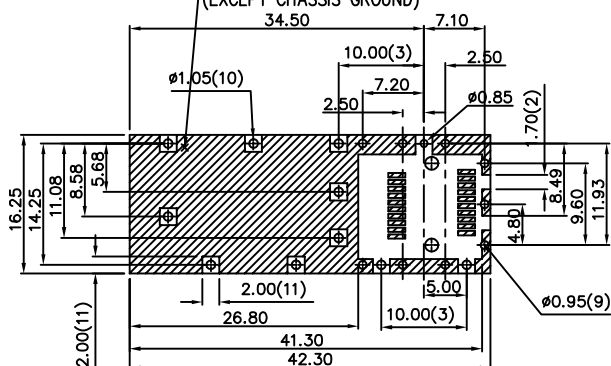

THIS AREA DENOTES COMPONENT KEEP-OUT (TRACES ALLOWED)
PCB LAYOUT (TOP VIEW)

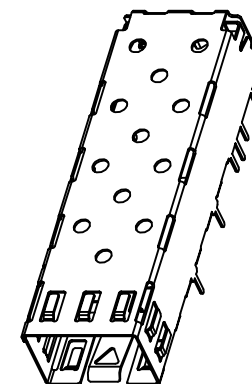
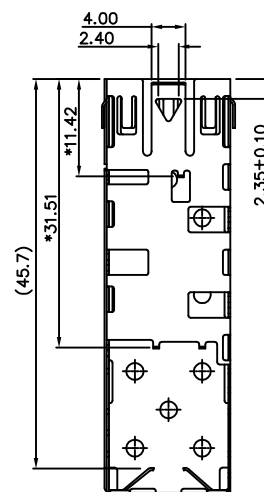

NOTE:
MECHANICAL:

SFP CAGE MATERIAL:
1. t=0.25, C5191 H,
NICKEL PLATING 30u"~80u"

SFP CONNECTOR MATERIAL:
1. LCP UL94V-0 BK.
2. t=0.20mm, C5191 H

PART NUMBER : N331X-023-0X

1- 3u" 2-6u" 1-TAB W/TIN PLATING W/O LOGO
3-15u" 4-30u" 2-TAB W/TIN PLATING W/T LOGO
5-50u"

△ XO	0000000	NEW DESIGN	LINGER	062207
MARK	ECN-NO.	REVISION RECORD	DRAWN	DATE
	UNLESS OTHERWISE SPECIFIED TOLERANCE		SCALE	CHECKED
	Dimension Range	Tolerance	1/1	sail
	X.X	±0.20	UNIT	APPROVED
	X.XX	±0.15	mm	peter
X.XXX	±0.10	SIZE	A3	SHEET 1/1
Contact Technology Co., Ltd.		ANGLE	±5°	
Material/Plated/Notes		NAME		
SEE NOTE		1X1 SFP CONNECTOR		
Tooling No.	PART NO.		SEE NOTE	
	DOC. NO.		NN330A023	
		REV.		0