

RoHS

THIS IS A RoHS
COMPLIANT
COMPONENT/
PRODUCT.

Suggested
Frame Size

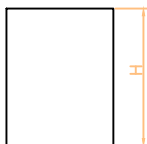

"H" FIT FOR 19.20-19.40

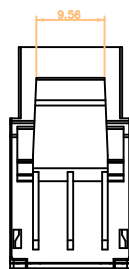
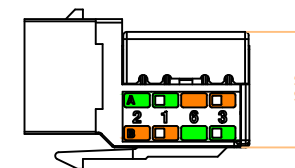
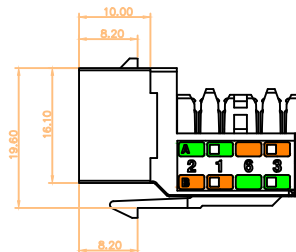
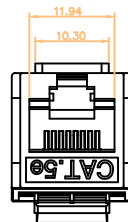
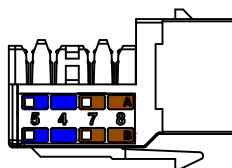
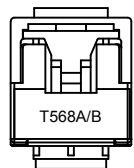
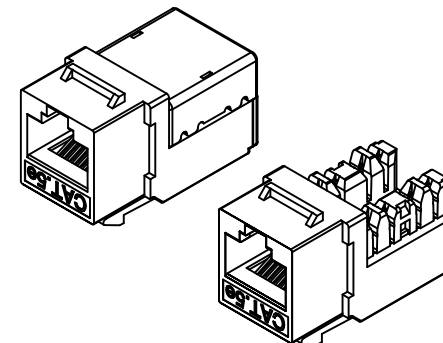
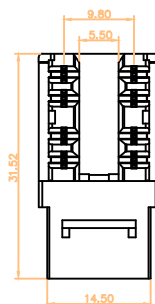

NOTES:

ELECTRICAL:

1. VOLTAGE RATING 125 VAC RMS.
2. CURRENT RATING 1.5 AMP.
3. CONTACT RESISTANCE 100 MILLIOHMS MAX.
4. INSULATION RESISTANCE 1000 MEGOHMS MIN @ 500 VDC.
5. DIELECTRIC STRENGTH: 750 VAC RMS 60Hz,1MIN.

ENVIRONMENTAL:

1. STORAGE: -40°C TO +85°C.
 2. OPERATION: -40°C TO +85°C.
- CONFORM TO TIA/EIA 568B
MATES WITH MODULAR PLUG CONFORMING TO TIA-1096-A.

MECHANICAL:

1. HOUSING MATERIAL: PC UL94V-0
 2. INSERT MATERIAL: PBT+30% GF. UL94V-0
 3. PCB MATERIAL: FR-4
 4. CONTACT MATERIAL: PHOSPHOR BRONZE T=0.35mm
 5. IDC CONTACT MATERIAL: PHOSPHOR BRONZE T=0.5mm WITH SILVER OR NICKEL PLATING
 6. WIRE : # 23~26AWG
 7. PART NUMBER: N442X-168-0X
- 1-3u" 2-6u" 3-15u" 1-19.6MM WHITE
4-30u" 5-50u"

△XO	000000	NEW DESIGN	LONNY	062023'	
MARK	ECN-NO.	REVISION RECORD	DRAWN	DATE	
 Contact Technology Co., Ltd. Material/Plated/Notes		UNLESS OTHERWISE SPECIFIED TOLERANCE	SCALE	CHECKED	
		Dimension Range Tolerance	1:1	APPROVED	
		X.X	±0.20	UNIT	
		X.XX	±0.15	mm	
X.XXX	±0.10	SIZE	A3	SHEET 1/1	
ANGLE	±5°				
SEE NOTE		NAME CAT.5e UTP 90° KEYSTONE			
Tooling No.	PART NO. SEE NOTE		REV. A		
	DOC. NO. NN442A168				